



# LEICA **ELMARIT-M** 28 mm f/2.8 ASPH.

Technical Data.



Illustrations 1:1

<b>Lens</b>	<b>Leica Elmarit-M 28 mm f/2.8 ASPH.</b>
Order number	11 677
Angle view (diagonal, horizontal, vertical)	For 35 mm (24x36 mm): 75°/65°/46°; for M8 (18x27mm): 60°/51°/36°, corresponds to a focal length of approx. 37mm with 35 mm-format
Optical design	Number of elements/groups: 8/6 Entrance pupil for bayonet: 11,8 mm Focusing range: 0,7m to infinity
Distance setting	Scala: combined meter-/feet-increments Smallest object field: for 35 mm: 533x800 mm, for M8: 400x600 mm Highest reproduction ratio: 1:22,2
Diaphragm	Setting/type: preset, with click-stops, half values available Smallest aperture: f/22 Number of aperture blades: 10
Bayonet	Leica M quick-change bayonet
Filter thread	E39
Lens hood	Available, screwable (supplied)
Dimensions and weight	Length: approx. 30,7/49,4 mm (without/with lens hood) Largest diameter without lens hood: approx. 52 mm Weight: approx. 175 g/211 g (without/with lens hood and covers)



# LEICA **ELMARIT-M** 28 mm f/2.8 ASPH.

ENGINEERING DRAWING

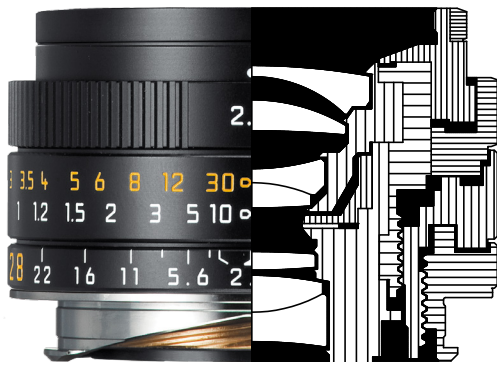

Illustrations 1:1

LENS SHAPE

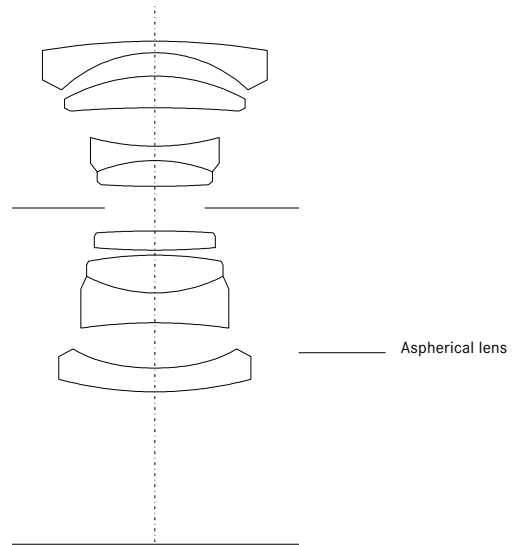

This new high-speed lens is the most compact of Leica M lenses. By using an aspherical element it was possible to attain top imaging performance with a weight of only 175 grams. This lens is practically distortion-free in the whole focus range from 0.7 m to infinity and only extends slightly into the viewfinder field of M cameras.



# LEICA **ELMARIT-M** 28 mm f/2.8 ASPH.

## MTF DIAGRAMS

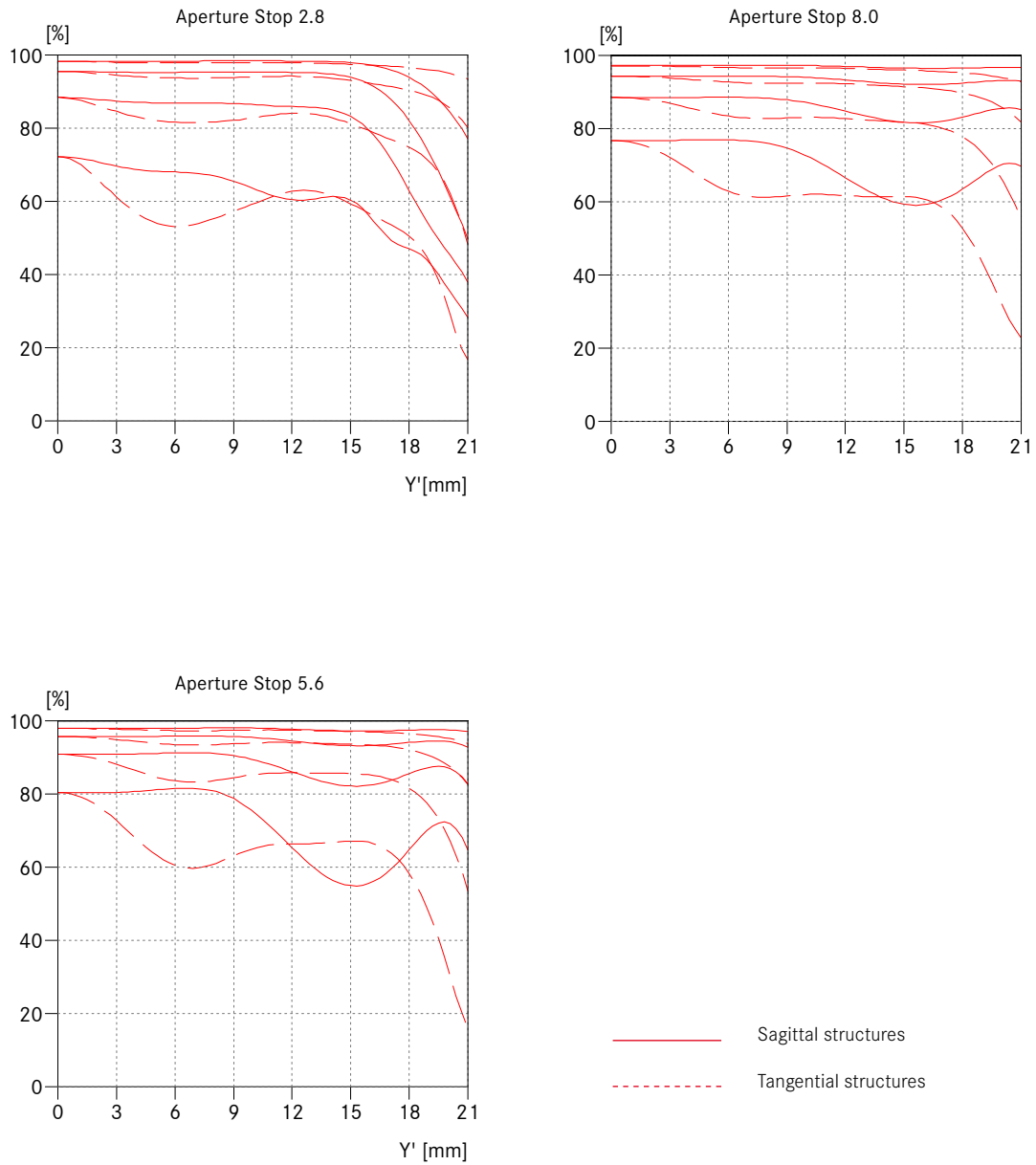

## MTF GRAPHS

The MTF is shown in each case for the maximum aperture and the aperture values 5.6 and 8.0 for long focusing distances (infinity). The contrast is plotted for 5, 10, 20, 40 lines/mm for the height of the format for tangential (dashed line) and sagittal structures (continuous line) for white light. The plots for 5 and 10 lines/mm provide an impression of the contrast performance for coarser object structures and the 20 and 40 lines/mm plots document the resolving power for fine and finest object structures.



# LEICA **ELMARIT-M** 28 mm f/2.8 ASPH.

## DISTORTION

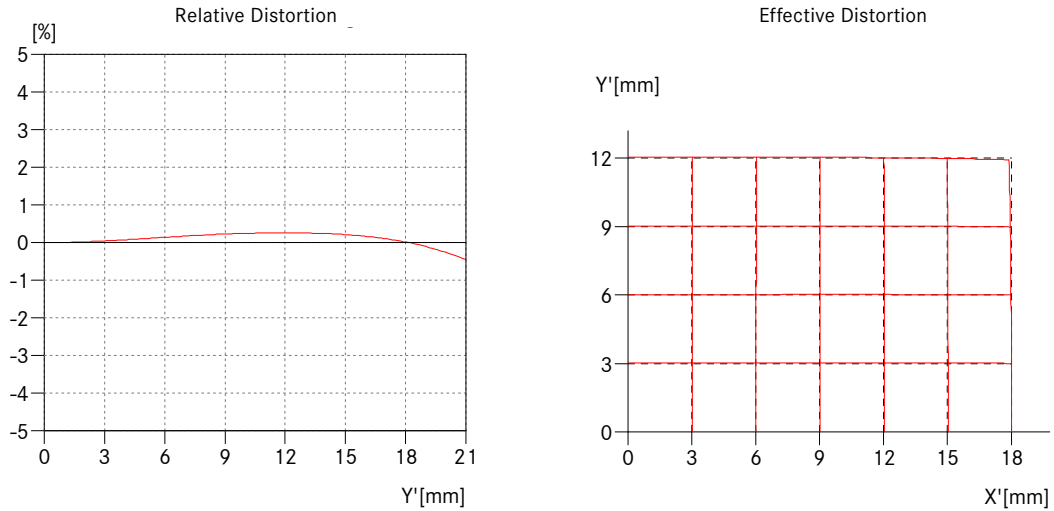

## VIGNETTING

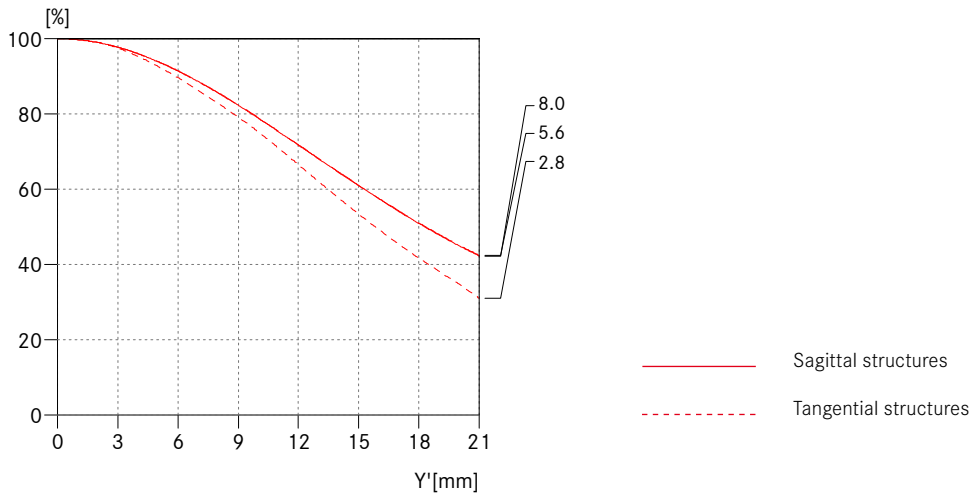

## DISTORTION

Distortion is the deviation of the real image height (in the picture) from the ideal image height. The relative distortion is the percentage deviation. The ideal image height results from the object height and the magnification. The image height of 21.6 mm is the radial distance between the edge and the middle of the image field for the format 24 mm x 36 mm. The graph of the effective distortion illustrates the appearance of straight horizontal and vertical lines in the picture.

## VIGNETTING

Vignetting is a continuous decrease of the illumination to the edges of the image field. The graph shows the percentage loss of illumination over the image height. 100% means no vignetting.



# LEICA **ELMARIT-M** 28 mm f/2.8 ASPH.

DEPTH OF FIELD TABLE

	Aperture Stop							Magnification
	2,8	4	5,6	8	11	16	22	
0,7	0,654 - 0,754	0,636 - 0,780	0,614 - 0,817	0,583 - 0,881	0,550 - 0,977	0,502 - 1,198	0,455 - 1,654	1/22,2
0,8	0,739 - 0,872	0,716 - 0,907	0,688 - 0,959	0,649 - 1,050	0,607 - 1,192	0,548 - 1,546	0,492 - 2,424	1/25,7
1	0,905 - 1,118	0,870 - 1,178	0,827 - 1,269	0,771 - 1,438	0,711 - 1,726	0,631 - 2,608	0,556 - 6,945	1/32,8
1,2	1,064 - 1,377	1,015 - 1,471	0,957 - 1,618	0,882 - 1,906	0,803 - 2,458	0,700 - 4,810	0,609 - ∞	1/39,8
1,5	1,291 - 1,793	1,219 - 1,957	1,135 - 2,231	1,029 - 2,829	0,922 - 4,272	0,788 - 30,92	0,672 - ∞	1/50,3
2	1,641 - 2,566	1,525 - 2,923	1,394 - 3,590	1,235 - 5,480	1,083 - 16,30	0,900 - ∞	0,750 - ∞	1/67,9
3	2,251 - 4,515	2,035 - 5,770	1,806 - 9,188	1,545 - 87,40	1,311 - ∞	1,050 - ∞	0,849 - ∞	1/103
5	3,204 - 11,51	2,780 - 26,15	2,365 - ∞	1,934 - ∞	1,577 - ∞	1,210 - ∞	0,950 - ∞	1/173
10	4,695 - ∞	3,832 - ∞	3,080 - ∞	2,383 - ∞	1,861 - ∞	1,368 - ∞	1,042 - ∞	1/349
∞	8,782 - ∞	6,163 - ∞	4,416 - ∞	3,104 - ∞	2,268 - ∞	1,572 - ∞	1,154 - ∞	1/∞

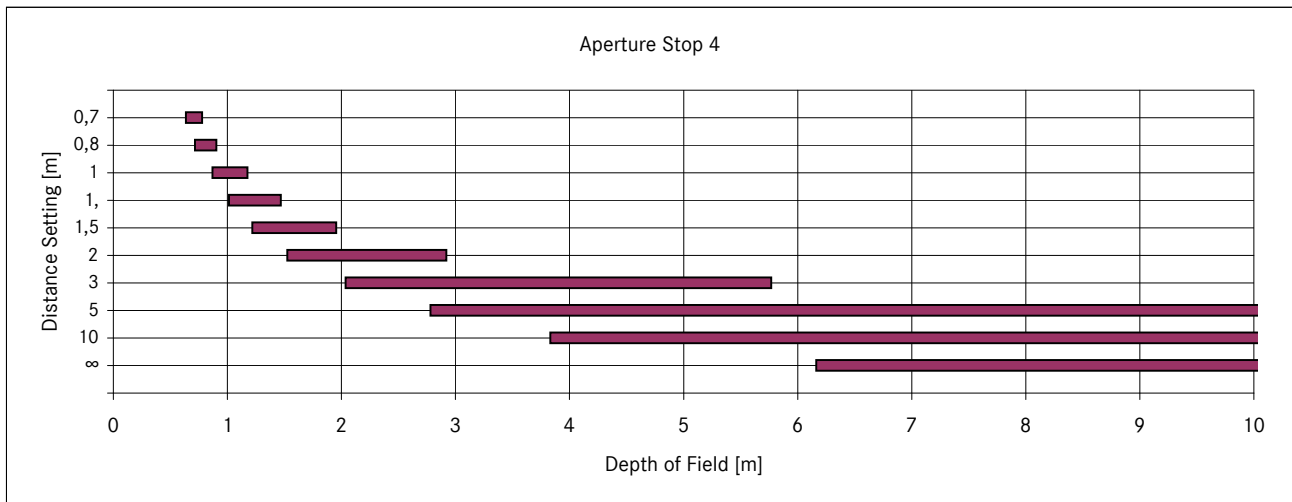
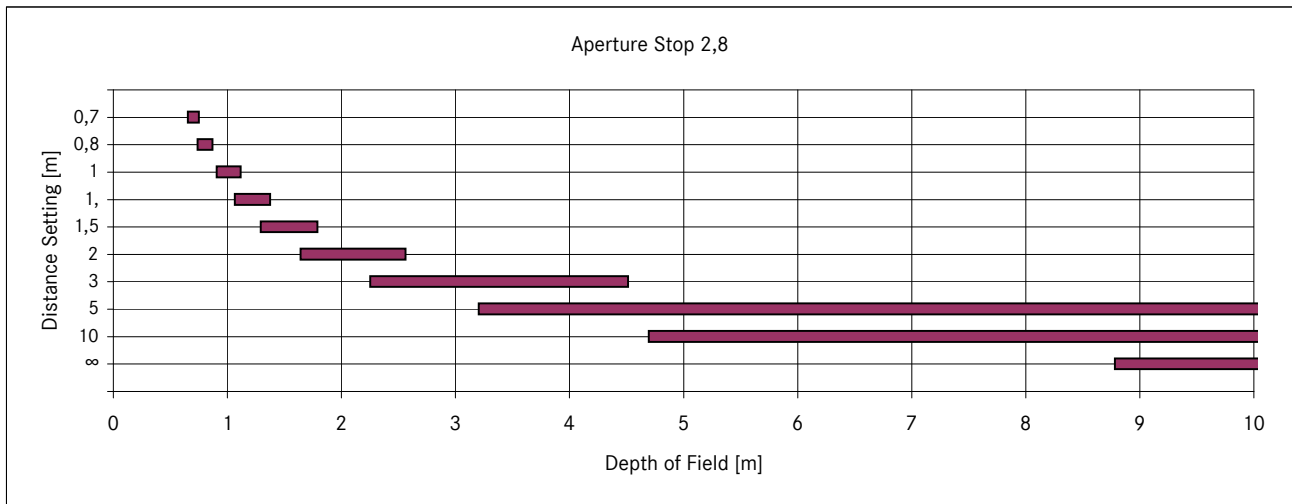



# LEICA **ELMARIT-M** 28 mm f/2.8 ASPH.

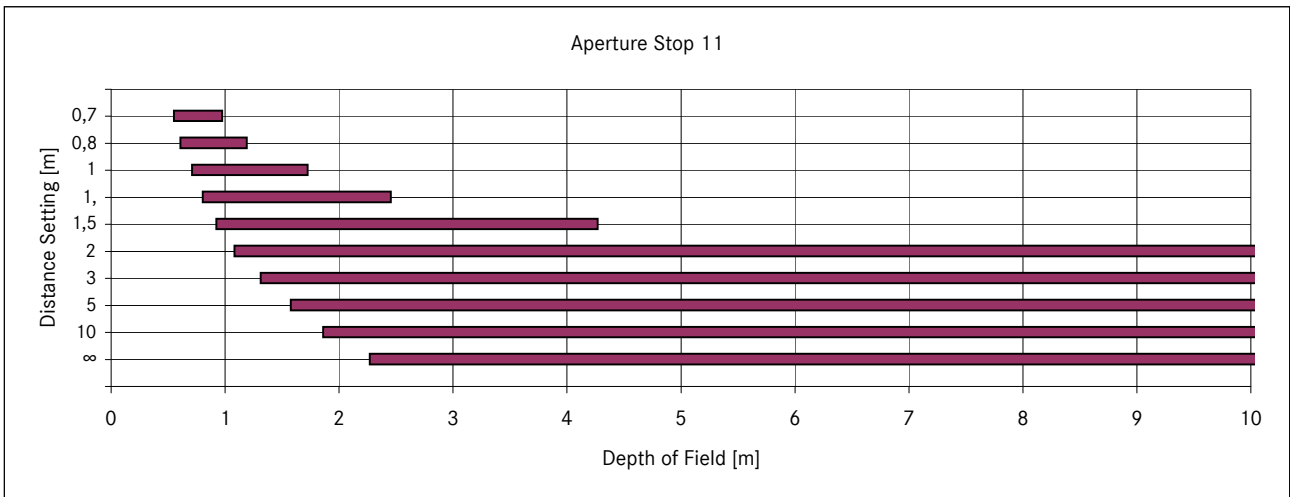
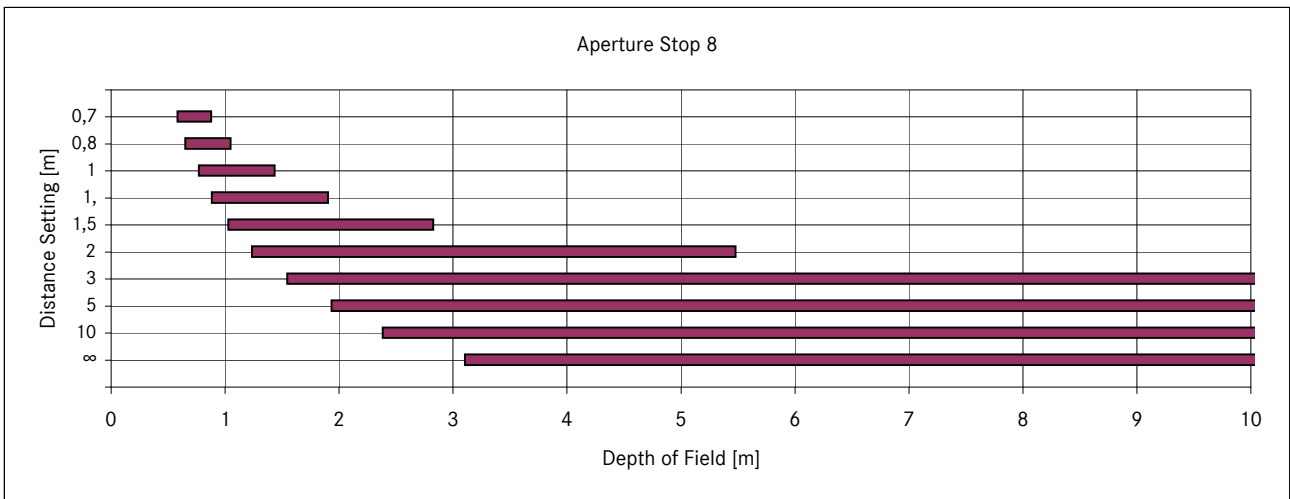
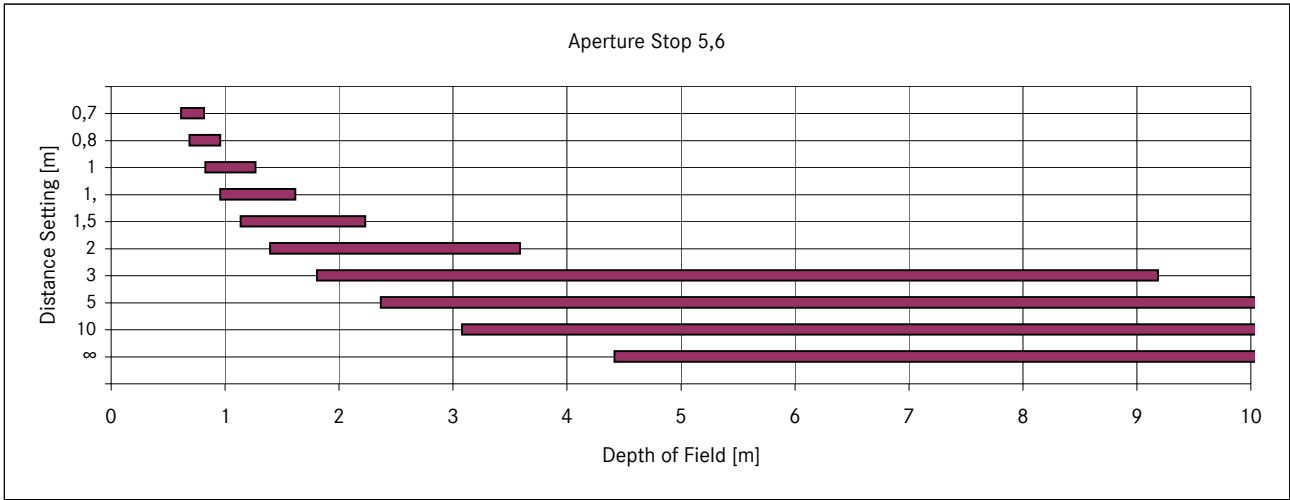



# LEICA **ELMARIT-M** 28 mm f/2.8 ASPH.

